

**Warsaw University
of Technology**



**Faculty of Power and
Aeronautical Engineering**

WARSAW UNIVERSITY OF TECHNOLOGY

Institute of Aeronautics and Applied Mechanics

Finite element method (FEM)

Plane frame. Example 1.

05.2021

EXAMPLE. BUILD A FE MODEL OF A 2-D FRAME. FIND NODAL DISPLACEMENTS, STRESSES, INTERNAL FORCES AND REACTIONS, CHECK EQUILIBRIUM.

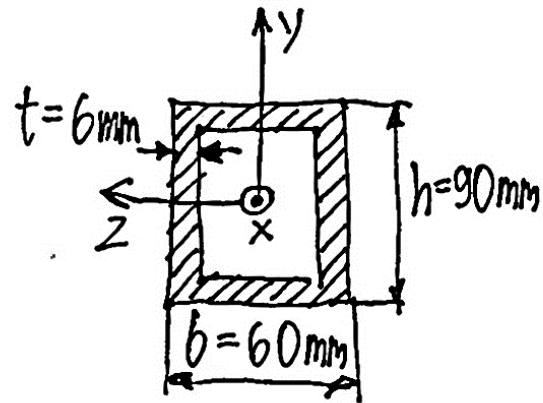
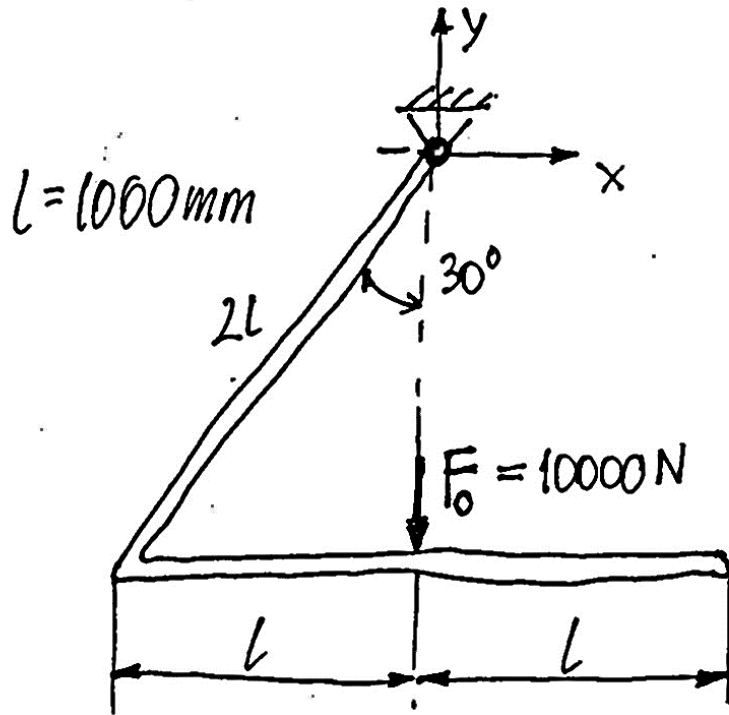

$$A = bh - (b-2t)(h-2t) = 1656 \text{ mm}^2$$

$$J_z = \frac{bh^3}{12} - \frac{(b-2t)(h-2t)^3}{12} = 1.7468 \cdot 10^6 \text{ mm}^4$$

NODAL PARAMETERS

$$\{q\} = \begin{Bmatrix} u_1 \\ v_1 \\ \textcircled{1}_1 \\ u_2 \\ v_2 \\ \textcircled{2}_2 \\ u_3 \\ v_3 \\ \textcircled{3}_3 \\ u_4 \\ v_4 \\ \textcircled{4}_4 \end{Bmatrix}$$

12×1

$$\begin{aligned} u_1 &= 0 \\ v_1 &= 0 \\ u_3 &= 0 \end{aligned}$$

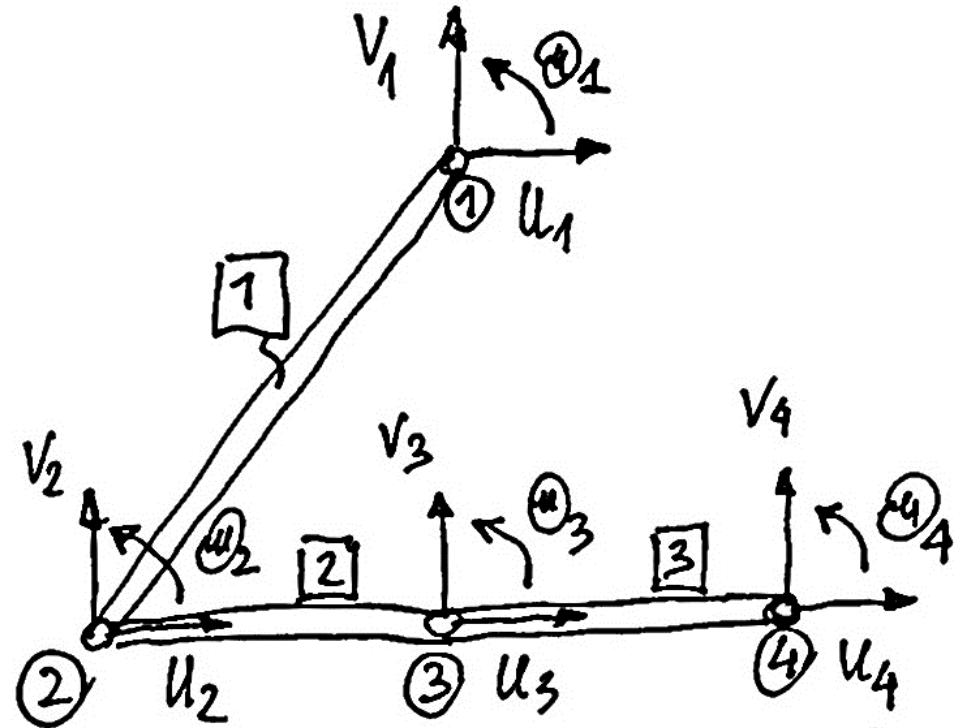

LOADS

F.B.D.

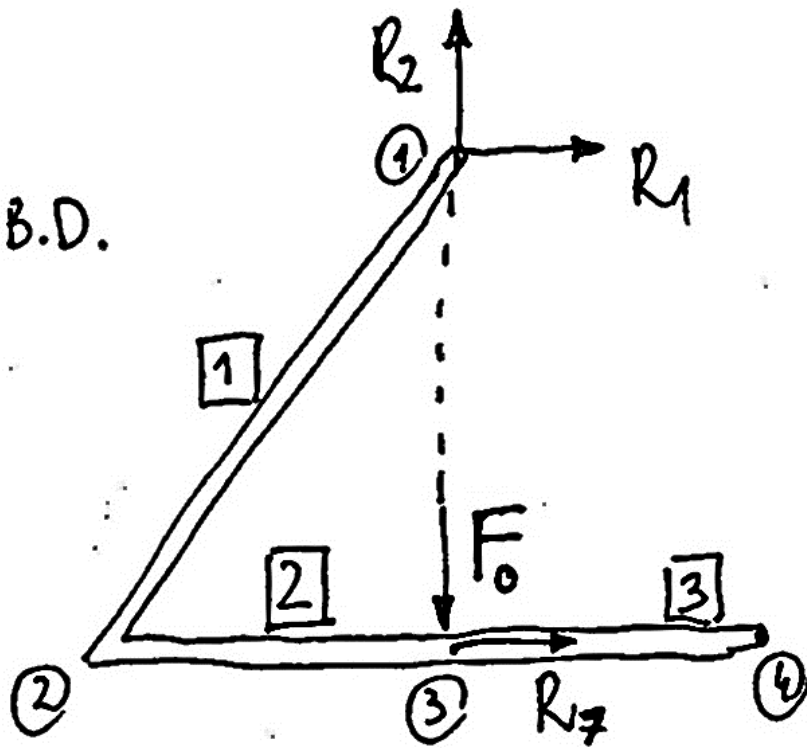

$$\{F\}_{12 \times 1} = \begin{Bmatrix} R_1 \\ R_2 \\ 0 \\ 0 \\ 0 \\ 0 \\ R_7 \\ -F_0 \\ 0 \\ 0 \\ 0 \\ 0 \end{Bmatrix}$$

1

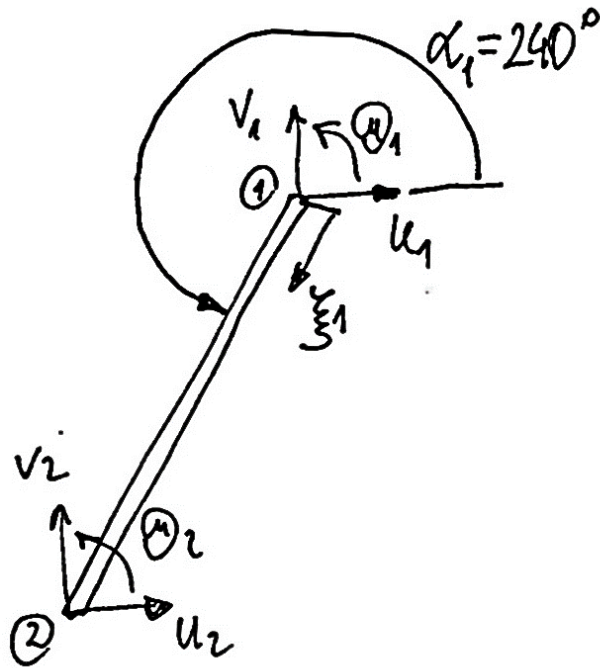

STIFFNESS MATRIX

$$C_1 = -\frac{1}{2}$$

$$S_1 = -\frac{\sqrt{3}}{2}$$

$$[q]_1 = [u_1, v_1, \theta_1, u_2, v_2, \theta_2]$$

1x6

$$[k]_1 =$$

6x6

$$\begin{bmatrix} \frac{EA}{2L} & 0 & 0 & -\frac{EA}{2L} & 0 & 0 \\ 0 & \frac{12EJ_2}{8L^3} & \frac{6EJ_2}{4L^2} & 0 & -\frac{12EJ_2}{8L^3} & \frac{6EJ_2}{4L^2} \\ 0 & \frac{6EJ_2}{4L^2} & \frac{4EJ_2}{2L} & 0 & -\frac{6EJ_2}{4L^2} & \frac{2EJ_2}{2L} \\ -\frac{EA}{2L} & 0 & 0 & \frac{EA}{2L} & 0 & 0 \\ 0 & -\frac{12EJ_2}{8L^3} & -\frac{6EJ_2}{4L^2} & 0 & \frac{12EJ_2}{8L^3} & -\frac{6EJ_2}{4L^2} \\ 0 & \frac{6EJ_2}{4L^2} & \frac{2EJ_2}{2L} & 0 & -\frac{6EJ_2}{4L^2} & \frac{4EJ_2}{2L} \end{bmatrix}$$

transformation matrix:

$$[T_f]_e = \begin{bmatrix} c & s & 0 & 0 & 0 & 0 \\ -s & c & 0 & 0 & 0 & 0 \\ 0 & 0 & 1 & 0 & 0 & 0 \\ 0 & 0 & 0 & c & s & 0 \\ 0 & 0 & 0 & -s & c & 0 \\ 0 & 0 & 0 & 0 & 0 & 1 \end{bmatrix}$$

$$[T_f]_1 = \begin{bmatrix} -\frac{1}{2} & -\frac{\sqrt{3}}{2} & 0 & 0 & 0 & 0 \\ \frac{\sqrt{3}}{2} & -\frac{1}{2} & 0 & 0 & 0 & 0 \\ 0 & 0 & 1 & 0 & 0 & 0 \\ 0 & 0 & 0 & -\frac{1}{2} & -\frac{\sqrt{3}}{2} & 0 \\ 0 & 0 & 0 & \frac{\sqrt{3}}{2} & -\frac{1}{2} & 0 \\ 0 & 0 & 0 & 0 & 0 & 1 \end{bmatrix}$$

$$[T_f]_1^T = \begin{bmatrix} -\frac{1}{2} & \frac{\sqrt{3}}{2} & 0 & 0 & 0 & 0 \\ -\frac{\sqrt{3}}{2} & -\frac{1}{2} & 0 & 0 & 0 & 0 \\ 0 & 0 & 1 & 0 & 0 & 0 \\ 0 & 0 & 0 & -\frac{1}{2} & \frac{\sqrt{3}}{2} & 0 \\ 0 & 0 & 0 & \frac{\sqrt{3}}{2} & -\frac{1}{2} & 0 \\ 0 & 0 & 0 & 0 & 0 & 1 \end{bmatrix}$$

STIFFNESS MATRIX

1

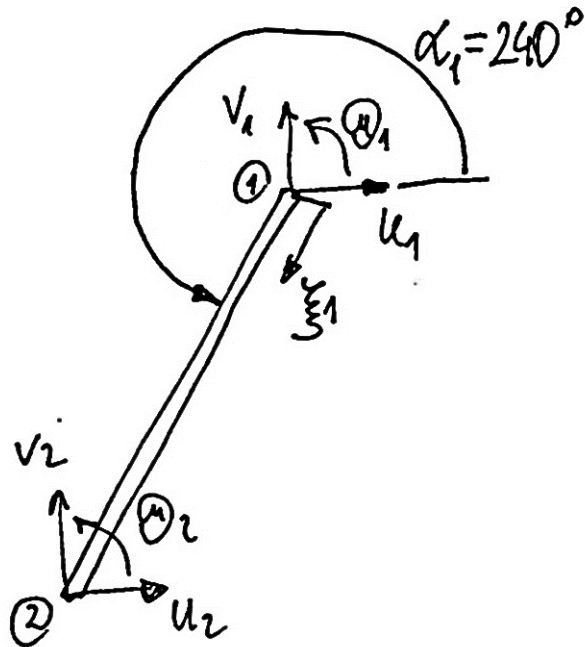

$$[k_g]_1 = [T_f]_1^T [k]_1 [T_f]_1$$

6×6 6×6 6×6 6×6

$$[K_g]_1^* = \begin{bmatrix} [k_g]_1 & [0] \\ [0] & [0] \end{bmatrix}$$

12×12 6×6 6×6

STIFFNESS MATRIX

2

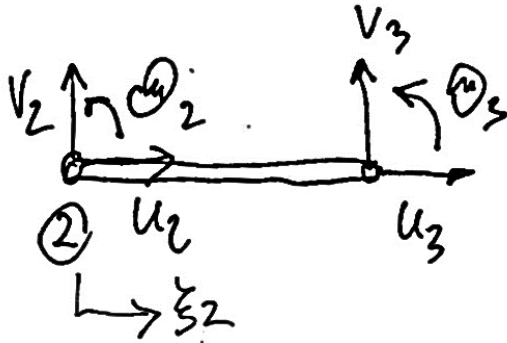

$$\alpha_2 = 0^\circ, \quad c_2 = 1, \quad s_2 = 0$$

$$[q, q]_2 = [u_2, v_2, \theta_2, u_3, v_3, \theta_3]$$

1 x 6

$$[K]_2 = \begin{bmatrix} \frac{EA}{L} & 0 & 0 & -\frac{EA}{L} & 0 & 0 \\ 0 & \frac{12EJ_2}{L^3} & \frac{6EJ_2}{L^2} & 0 & -\frac{12EJ_2}{L^3} & \frac{6EJ_2}{L^2} \\ 0 & \frac{6EJ_2}{L^2} & \frac{4EJ_2}{L} & 0 & -\frac{6EJ_2}{L^2} & \frac{2EJ_2}{L} \\ -\frac{EA}{L} & 0 & 0 & \frac{EA}{L} & 0 & 0 \\ 0 & -\frac{12EJ_2}{L^3} & -\frac{6EJ_2}{L^2} & 0 & \frac{12EJ_2}{L^3} & -\frac{6EJ_2}{L^2} \\ 0 & \frac{6EJ_2}{L^2} & \frac{2EJ_2}{L} & 0 & -\frac{6EJ_2}{L^2} & \frac{4EJ_2}{L} \end{bmatrix}$$

6 x 6

Transformation matrix:

$$\begin{bmatrix} T_f \end{bmatrix}_2^{6 \times 6} = \begin{bmatrix} 1 & 0 & 0 & 0 & 0 & 0 \\ 0 & 1 & 0 & 0 & 0 & 0 \\ 0 & 0 & 1 & 0 & 0 & 0 \\ 0 & 0 & 0 & 1 & 0 & 0 \\ 0 & 0 & 0 & 0 & 1 & 0 \\ 0 & 0 & 0 & 0 & 0 & 1 \end{bmatrix} = \begin{bmatrix} T_f \end{bmatrix}_2^{6 \times 6 T}$$

$$\begin{bmatrix} K_g \end{bmatrix}_2^{6 \times 6} = \begin{bmatrix} T_f \end{bmatrix}_2^{6 \times 6 T} \begin{bmatrix} K \end{bmatrix}_2^{6 \times 6} \begin{bmatrix} T_f \end{bmatrix}_2^{6 \times 6} = \begin{bmatrix} k \end{bmatrix}_2^{6 \times 6}$$

STIFFNESS MATRIX

2

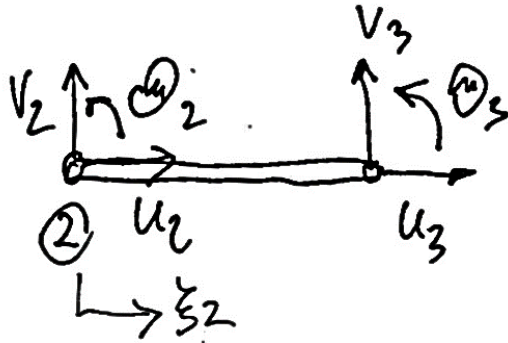

$$[K_g]_2^* =$$

12×12

$$= \begin{bmatrix} [0]_{3 \times 3} & [0]_{3 \times 6} & [0]_{3 \times 3} \\ [0]_{6 \times 3} & [K_g]_2 & [0]_{6 \times 3} \\ [0]_{3 \times 3} & [0]_{3 \times 6} & [0]_{3 \times 3} \end{bmatrix}$$

6×6

STIFFNESS MATRIX

[3]

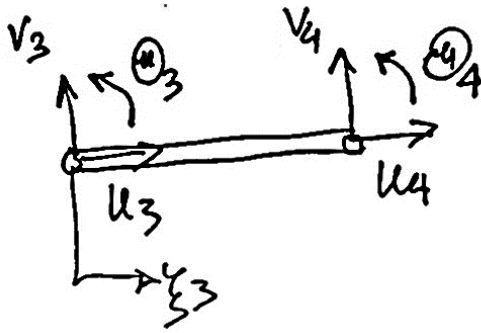

$$\alpha_3 = 0^\circ, \quad C_3 = 1, \quad S_3 = 0$$

$$[q_g]_3 = [u_3, v_3, \theta_3, u_4, v_4, \theta_4]$$

1×6

$$[k]_3 = [k]_2, \quad [T_f]_3 = [T_f]_3^T = [T_f]_2$$

6×6 6×6 6×6 6×6

$$[k_g]_3 = [k_g]_2 = [k]_3$$

6×6 6×6 6×6

$$[k_g]_3^* =$$

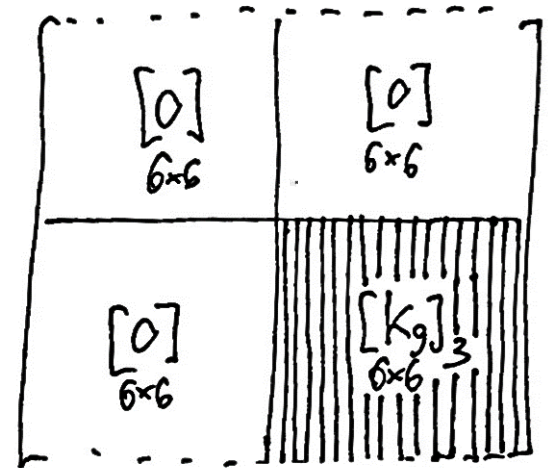

GLOBAL STIFFNESS MATRIX

$$[K]_{12 \times 12} = [K_g]_{12 \times 12}^* + [K_g]_{12 \times 12}^* + [K_g]_{12 \times 12}^* =$$

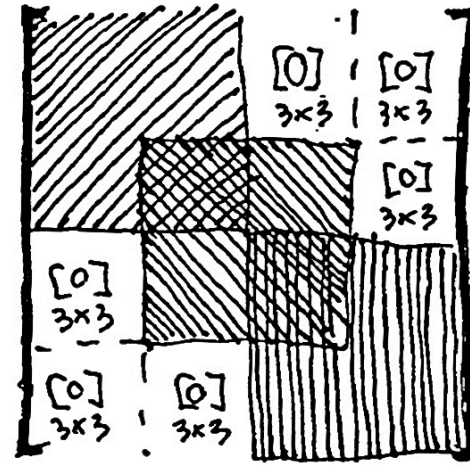

SET OF EQUATIONS

$$[K]_{12 \times 12} \cdot \{q\}_{12 \times 1} = \{F\}_{12 \times 1} + \text{boundary conditions}$$

$$u_1 = 0, v_1 = 0, u_3 = 0$$

$$[K]_{9 \times 9} \cdot \begin{Bmatrix} u_1 \\ u_2 \\ v_2 \\ u_2 \\ v_3 \\ u_3 \\ u_4 \\ v_4 \\ u_4 \end{Bmatrix} = \begin{Bmatrix} 0 \\ 0 \\ 0 \\ 0 \\ -10000 \\ 0 \\ 0 \\ 0 \\ 0 \end{Bmatrix}$$

$$([K]_{9 \times 9} = [K]_{12 \times 12} \text{ without rows and columns no. 1, 2, 7})$$

DOF SOLUTION

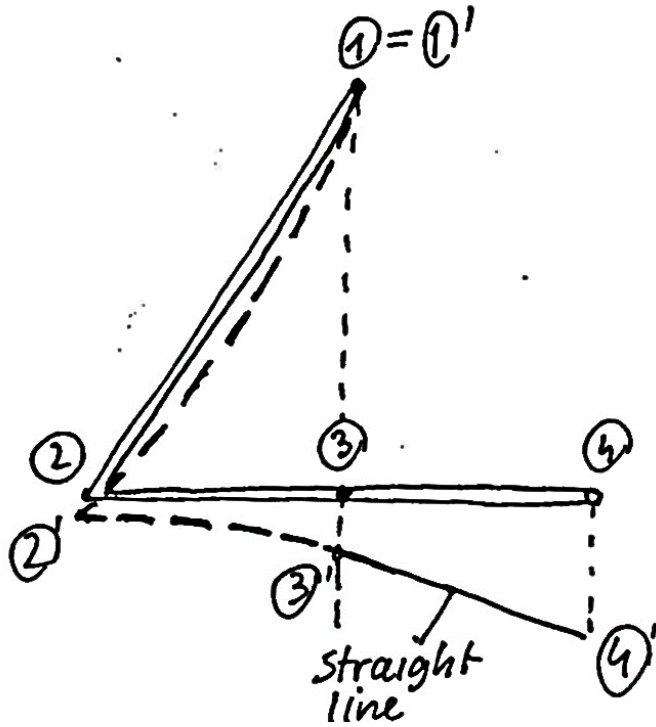

$$\begin{Bmatrix} q_1 \\ q_2 \end{Bmatrix}_{9 \times 1} = [K]_{9 \times 9}^{-1} \cdot \begin{Bmatrix} F \end{Bmatrix}_{9 \times 1}$$

$$= \begin{Bmatrix} 0.00956 \\ 0 \\ -0.0604 \\ -0.01907 \\ -28.6692 \\ -0.0334 \\ 0 \\ -62.0486 \\ -0.0334 \end{Bmatrix} \begin{matrix} (\text{rad}) \\ (\text{mm}) \\ (\text{mm}) \\ (\text{rad}) \\ (\text{mm}) \\ (\text{rad}) \\ (\text{mm}) \\ (\text{mm}) \\ (\text{rad}) \end{matrix} = \begin{Bmatrix} \textcircled{1}_1 \\ u_2 \\ v_2 \\ \textcircled{2}_2 \\ v_3 \\ \textcircled{4}_3 \\ u_4 \\ v_4 \\ \textcircled{4}_4 \end{Bmatrix}$$

REACTIONS

$$\begin{array}{l}
 [K] \cdot \{q\} = \begin{Bmatrix} R_1 \\ R_2 \\ 0 \\ 0 \\ 0 \\ 0 \\ R_7 \\ -F_0 \\ 0 \\ 0 \\ 0 \\ 0 \end{Bmatrix} \\
 12 \times 12 \quad 12 \times 1
 \end{array}
 \Rightarrow R_1 = 0 \text{ N}$$

$$\Rightarrow R_2 = 10000 \text{ N}$$

$$\Rightarrow R_7 = 0 \text{ N}$$

(additional constraint $u_3 = 0$ did not change the deformation)

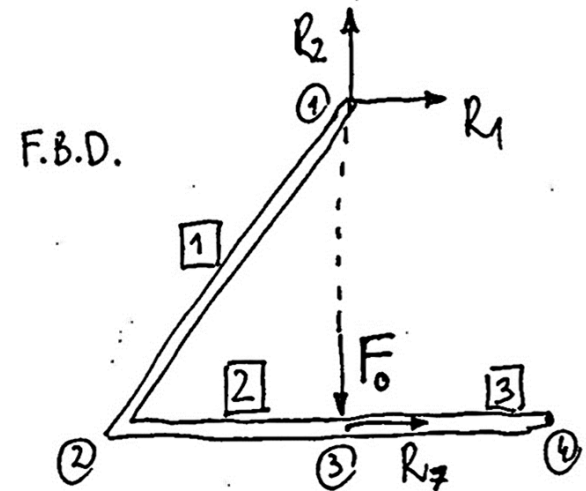

stresses and internal forces :

[1]

$$\begin{Bmatrix} q_1 \\ q_2 \\ q_3 \\ q_4 \\ q_5 \\ q_6 \end{Bmatrix}_1 = \begin{bmatrix} T_f \\ \end{bmatrix}_{6 \times 6} \cdot \begin{Bmatrix} q_9 \end{Bmatrix}_{6 \times 1} = \begin{bmatrix} T_f \\ \end{bmatrix}_{6 \times 6} \cdot \begin{Bmatrix} u_1 \\ v_1 \\ \textcircled{u}_1 \\ u_2 \\ v_2 \\ \textcircled{u}_2 \end{Bmatrix}_1 =$$

$$= \begin{bmatrix} -\frac{1}{2} & -\frac{\sqrt{3}}{2} & 0 & 0 & 0 & 0 \\ \frac{\sqrt{3}}{2} & -\frac{1}{2} & 0 & 0 & 0 & 0 \\ 0 & 0 & 1 & 0 & 0 & 0 \\ 0 & 0 & 0 & -\frac{1}{2} & -\frac{\sqrt{3}}{2} & 0 \\ 0 & 0 & 0 & \frac{\sqrt{3}}{2} & -\frac{1}{2} & 0 \\ 0 & 0 & 0 & 0 & 0 & 1 \end{bmatrix} \cdot \begin{Bmatrix} 0 \\ 0 \\ 0.00956 \\ 0 \\ -0.0604 \\ -0.01907 \end{Bmatrix}_1 = \begin{Bmatrix} 0 \\ 0 \\ 0.00956 \\ 0.0523 \\ 0.0302 \\ -0.01907 \end{Bmatrix}_1$$

stresses and internal forces :

1

$$\begin{Bmatrix} q_1 \\ q_2 \\ q_3 \\ q_4 \\ q_5 \\ q_6 \end{Bmatrix}_1 = \begin{Bmatrix} 0 \\ 0 \\ 0.00956 \\ 0.0523 \\ 0.0302 \\ -0.01907 \end{Bmatrix}_1$$

BAR :

$$\sigma_1 = \frac{E}{2L} (q_4 - q_1) = 5.23 \text{ MPa}$$

$$N_1 = \sigma_1 \cdot A = 8660.254 \text{ N}$$

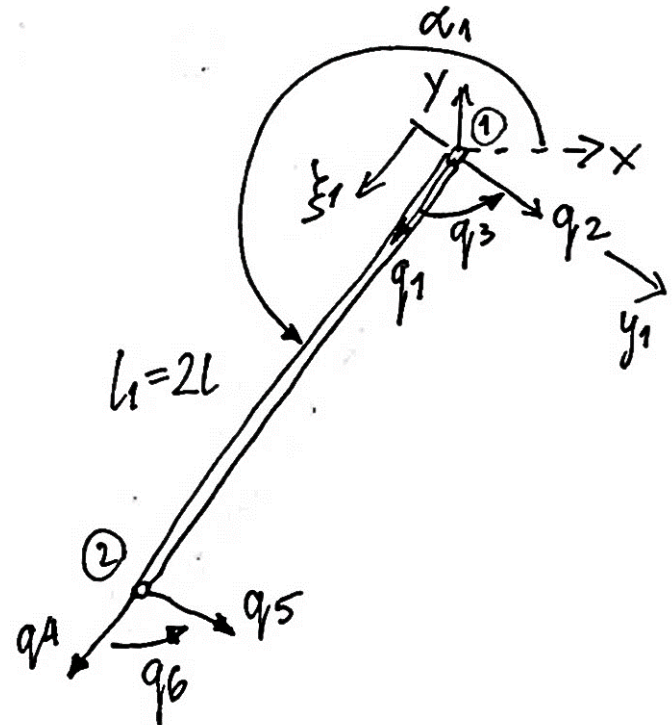

BEAM:

$$M_{z_1}(\xi_1) = EJ_2 \cdot W_1'' = EJ_2 \cdot \underset{1 \times 4}{LN''} \cdot \begin{Bmatrix} q_2 \\ q_3 \\ q_5 \\ q_6 \end{Bmatrix}_1 =$$

$$= EJ_2 \left[-\frac{6}{l_1^2} + \frac{12}{l_1^3} \xi_1, \frac{-4}{l_1} + \frac{6}{l_1^2} \xi_1, \frac{6}{l_1} - \frac{12}{l_1^3} \xi_1, -\frac{2}{l_1} + \frac{6}{l_1^2} \xi_1 \right] \cdot \begin{Bmatrix} q_1 \\ q_2 \\ q_5 \\ q_6 \end{Bmatrix}_1 \Rightarrow$$

$$\Rightarrow M_{z_1}(0) = 0, \quad M_{z_1}(2L) = -1 \cdot 10^7 \text{ Nmm}$$

$$T_{y_1} = -EJ_2 \cdot W_1''' = -EJ_2 \cdot \underset{1 \times 4}{LN'''} \cdot \begin{Bmatrix} q_2 \\ q_3 \\ q_5 \\ q_6 \end{Bmatrix}_1 =$$

$$= -EJ_2 \left[\frac{12}{l_1^3}, \frac{6}{l_1^2}, -\frac{12}{l_1^3}, \frac{6}{l_1^2} \right] \cdot \begin{Bmatrix} q_2 \\ q_3 \\ q_5 \\ q_6 \end{Bmatrix}_1 = 5000 \text{ N}$$

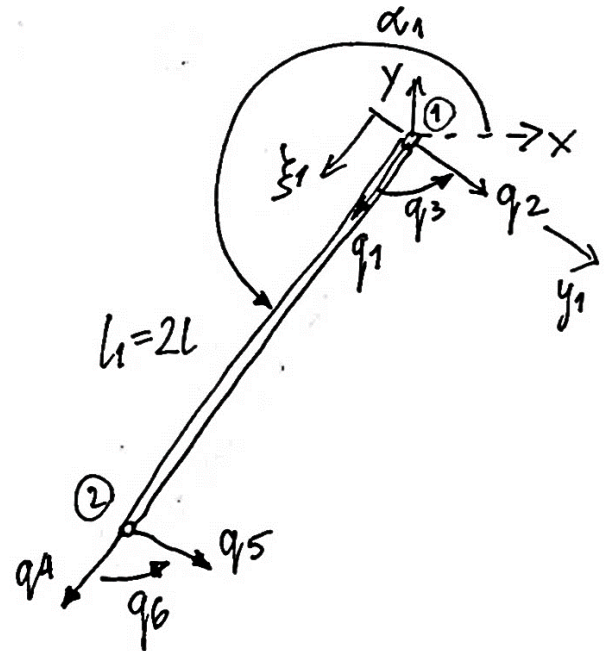

1

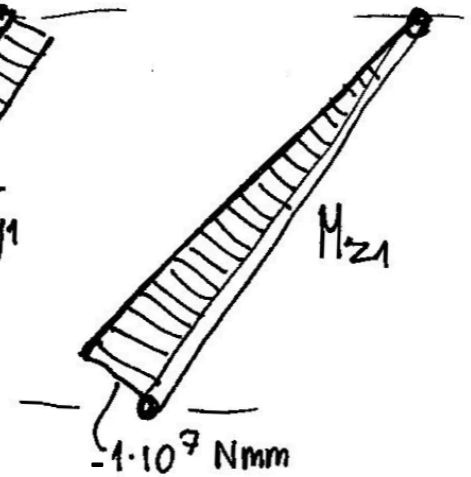
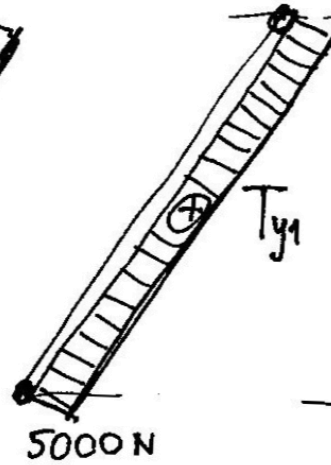
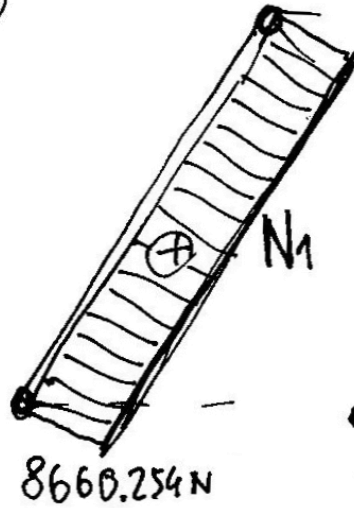
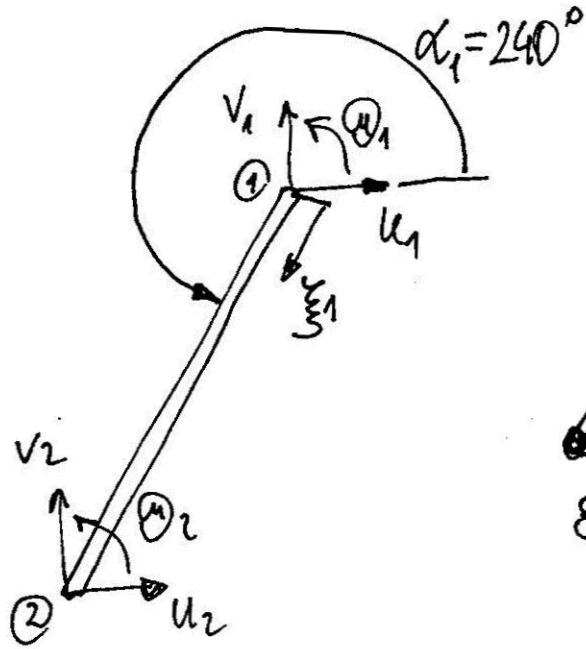

$$\sigma_{1B} \left(\frac{y}{2}, y_1 \right) = - \frac{M_{z1}(\xi_1) \cdot y_1}{J_z}$$

$$\begin{aligned} \sigma_{1B} \left(2L, \frac{h}{2} \right) &= \frac{-(-1 \cdot 10^7 \text{ Nmm}) \cdot \frac{h}{2}}{J_z} \\ &= 257,62 \text{ MPa} \end{aligned}$$

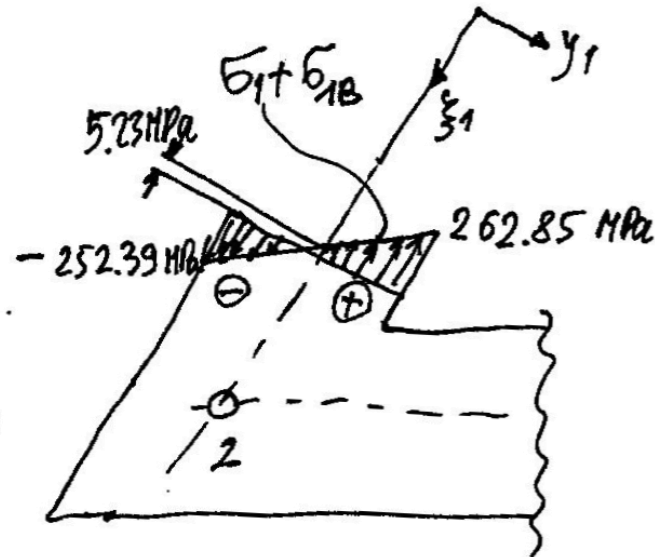

stresses and internal forces :

[2]

$$\begin{Bmatrix} q_1 \\ q_2 \\ q_3 \\ q_4 \\ q_5 \\ q_6 \end{Bmatrix}_2 = \begin{bmatrix} T_f \\ 6 \times 6 \end{bmatrix}_2 \cdot \begin{Bmatrix} q_1 \\ q_2 \end{Bmatrix}_2 = \begin{bmatrix} T_f \\ 6 \times 6 \end{bmatrix}_2 \cdot \begin{Bmatrix} u_2 \\ v_2 \\ \theta_2 \\ u_3 \\ v_3 \\ \theta_3 \end{Bmatrix}_2 =$$

$$= \begin{bmatrix} 1 & 0 & 0 & 0 & 0 & 0 \\ 0 & 1 & 0 & 0 & 0 & 0 \\ 0 & 0 & 1 & 0 & 0 & 0 \\ 0 & 0 & 0 & 1 & 0 & 0 \\ 0 & 0 & 0 & 0 & 1 & 0 \\ 0 & 0 & 0 & 0 & 0 & 1 \end{bmatrix} \cdot \begin{Bmatrix} 0 \\ -0.0604 \\ -0.01907 \\ 0 \\ -28.6692 \\ -0.03334 \end{Bmatrix}_2 = \begin{Bmatrix} 0 \\ -0.0604 \\ -0.01907 \\ 0 \\ -28.6692 \\ -0.03334 \end{Bmatrix}_2$$

stresses and internal forces :

②

$$\begin{Bmatrix} q_1 \\ q_2 \\ q_3 \\ q_4 \\ q_5 \\ q_6 \end{Bmatrix}_2 = \begin{Bmatrix} 0 \\ -0.0604 \\ -0.01907 \\ 0 \\ -28.6692 \\ -0.03334 \end{Bmatrix}_2$$

BAR:

$$\sigma_2 = \frac{E}{L} (q_4 - q_1)_2 = 0$$

$$N_2 = \sigma_2 \cdot A = 0$$

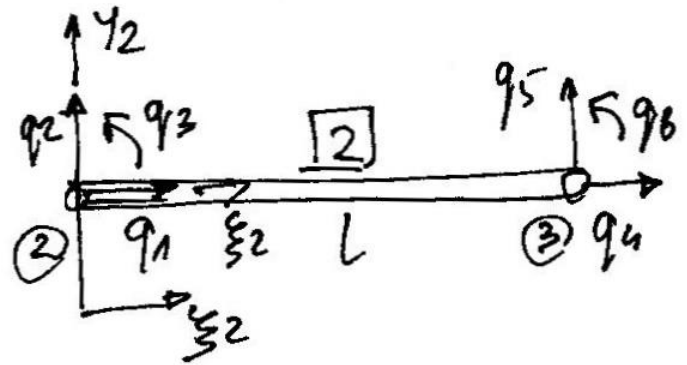

BEAM:

$$M_{z_2}(\xi_2) = EJ_2 \cdot w_2'' = EJ_2 \cdot \underbrace{[N^4]}_{1 \times 4} \cdot \begin{Bmatrix} q_2 \\ q_3 \\ q_5 \\ q_6 \end{Bmatrix}_2 =$$

$$= EJ_2 \left[-\frac{6}{l^2} + \frac{12}{l^3} \xi_2, -\frac{4}{l} + \frac{6}{l^2} \xi_2, \frac{6}{l^2} - \frac{12}{l^3} \xi_2, -\frac{2}{l} + \frac{6}{l^2} \xi_2 \right] \cdot \begin{Bmatrix} q_2 \\ q_3 \\ q_5 \\ q_6 \end{Bmatrix}_2 \Rightarrow$$

$$M_{z_2}(0) = -1 \cdot 10^7 \text{ Nmm} ; \quad M_{z_2}(l) = 0$$

$$T_{y_2} = -EJ_2 \cdot w_2''' = -EJ_2 \cdot [N^4] \cdot \begin{Bmatrix} q_2 \\ q_3 \\ q_5 \\ q_6 \end{Bmatrix}_2 =$$

$$= -EJ_2 \left[\frac{12}{l^3}, \frac{6}{l^2}, -\frac{12}{l^3}, \frac{6}{l^2} \right] \cdot \begin{Bmatrix} q_2 \\ q_3 \\ q_5 \\ q_6 \end{Bmatrix}_2 =$$

$$= -10000 \text{ N}$$

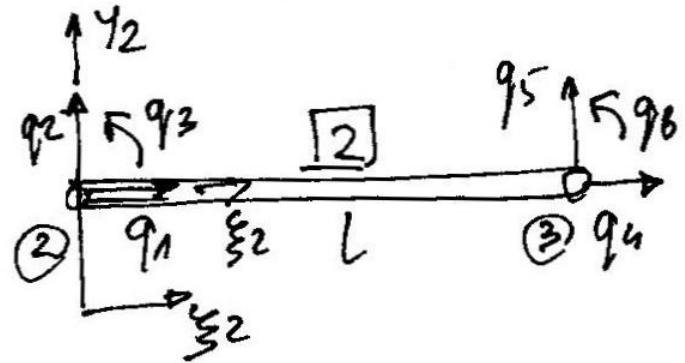

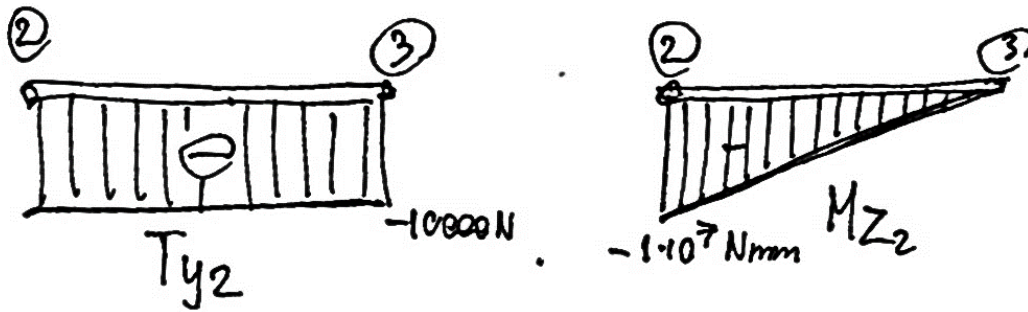

$$\sigma_{2B}(\xi_2, y_2) = - \frac{M_{z2}(\xi_2) \cdot y_2}{J_z}$$

$$\sigma_{2B}\left(0, \frac{h}{2}\right) = - \frac{(-1 \cdot 10^7 \text{ Nmm}) \cdot \frac{h}{2}}{J_z} = 257.62 \text{ MPa}$$

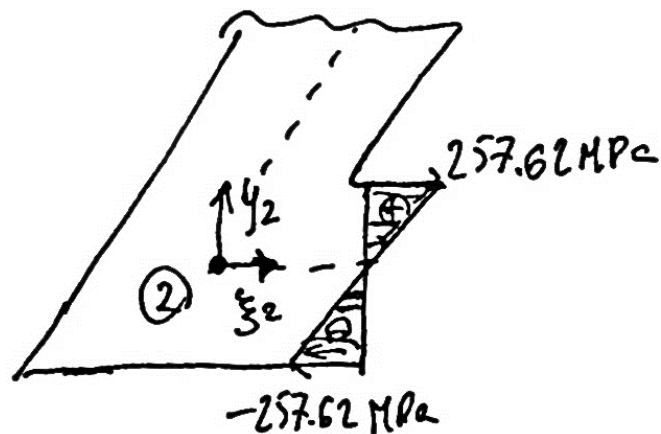

stresses and internal forces :

[3]

$$\begin{Bmatrix} q_1 \\ q_2 \\ q_3 \\ q_4 \\ q_5 \\ q_6 \end{Bmatrix}_3 = \begin{bmatrix} T_f \\ 6 \times 6 \end{bmatrix}_3 \cdot \begin{Bmatrix} q_9 \end{Bmatrix}_3 = \begin{bmatrix} 1 \\ 6 \times 6 \end{bmatrix} \cdot \begin{Bmatrix} u_3 \\ v_3 \\ \theta_3 \\ u_4 \\ v_4 \\ \theta_4 \end{Bmatrix}_3 = \begin{Bmatrix} 0 \\ -28.6692 \\ -0.0334 \\ 0 \\ -62.0486 \\ -0.0334 \end{Bmatrix}_3$$

BAR:

$$\sigma_3 = \frac{E}{L} (q_4 - q_1)_3 = 0$$

$$N_3 = \sigma_3 \cdot A = 0$$

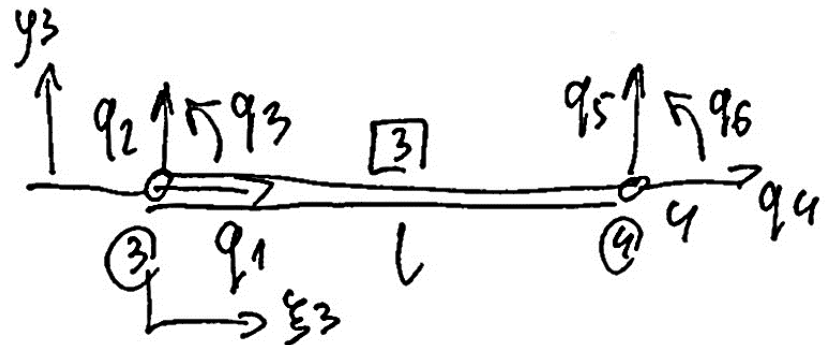

BEAM:

$$M_{23}(\xi_3) = EI_2 \cdot w_3'' = EI_2 \cdot \underbrace{LN''}_{1 \times 4} \cdot \begin{Bmatrix} q_2 \\ q_3 \\ q_5 \\ q_6 \end{Bmatrix}_3 =$$

$$= EI_2 \left[-\frac{6}{l^2} + \frac{12}{l^3} \xi_3, -\frac{4}{l} + \frac{6}{l^2} \xi_3, \frac{6}{l^2} - \frac{12}{l^3} \xi_3, -\frac{2}{l} + \frac{6}{l^2} \xi_3 \right] \cdot \begin{Bmatrix} q_2 \\ q_3 \\ q_5 \\ q_6 \end{Bmatrix}_3 =$$

$$= 0 \Rightarrow \sigma_{3B}(\xi_3, y_3) = 0$$

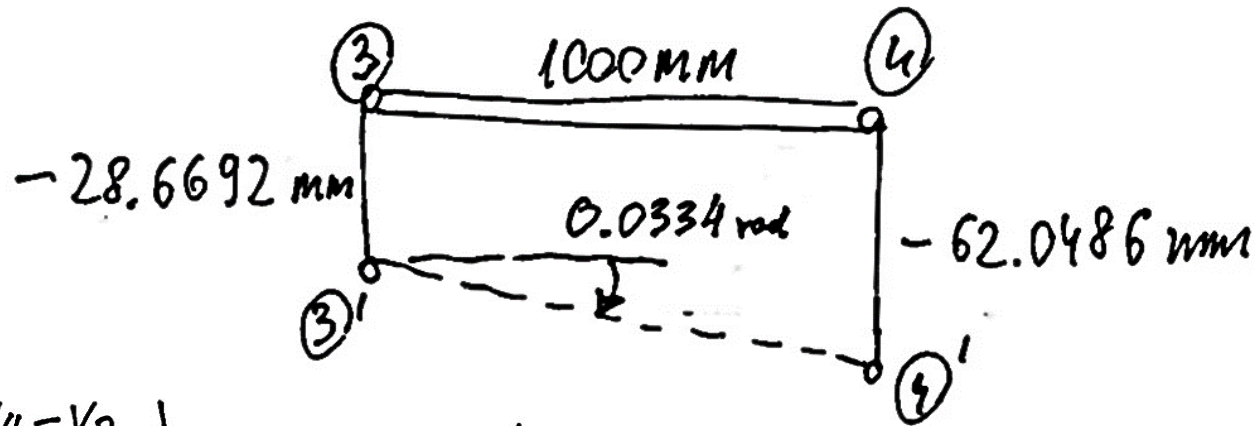

$$\text{atan} \left(\frac{v_4 - v_3}{l} \right) = -0.0334 \text{ rad}$$

equilibrium :

